

## FCC Verification Test Report

**Report No.:** FV170407D06

**Test Model:** ECS-4500-PoER

**Series Model:** Vecow ECS-4500 Series; ECS-4500-PoE;  
ECS-4500-PDR; ECS-4500-PD; ECS-4500-2R; ECS-4500-2G;  
ECS-4XXXXXXXXXXXXXXXXXXXXX (“X” can be 0-9, A-Z or blank for  
marketing purpose)

**Received Date:** Apr. 7, 2017

**Test Date:** Apr. 15 ~ 18, 2017

**Issued Date:** May 18, 2017

**Applicant:** Vecow Co., Ltd.

**Address:** 12F., No. 111, Zhongcheng Rd., Tucheng Dist., New Taipei City 23674  
Taiwan (R.O.C.)

**Issued By:** Bureau Veritas Consumer Products Services (H.K.) Ltd., Taoyuan Branch

**Lab Address:** No. 47-2, 14th Ling, Chia Pau Vil., Lin Kou Dist., New Taipei City, Taiwan  
(R.O.C.)



This report is for your exclusive use. Any copying or replication of this report to or for any other person or entity, or use of our name or trademark, is permitted only with our prior written permission. This report sets forth our findings solely with respect to the test samples identified herein. The results set forth in this report are not indicative or representative of the quality or characteristics of the lot from which a test sample was taken or any similar or identical product unless specifically and expressly noted. Our report includes all of the tests requested by you and the results thereof based upon the information that you provided to us. You have 60 days from date of issuance of this report to notify us of any material error or omission caused by our negligence, provided, however, that such notice shall be in writing and shall specifically address the issue you wish to raise. A failure to raise such issue within the prescribed time shall constitute your unqualified acceptance of the completeness of this report, the tests conducted and the correctness of the report contents. Unless specific mention, the uncertainty of measurement has been explicitly taken into account to declare the compliance or non-compliance to the specification. The report must not be used by the client to claim product certification, approval, or endorsement by NVLAP, NIST, or any agency of the federal government. The report must not be used by the client to claim product certification, approval, or endorsement by TAF or any government agencies.

## Table of Contents

<b>Release Control Record.....</b>	<b>3</b>
<b>1 Certificate of Conformity.....</b>	<b>4</b>
<b>2 Summary of Test Results.....</b>	<b>5</b>
2.1 Measurement Uncertainty.....	5
2.2 Modification Record.....	5
<b>3 General Information .....</b>	<b>6</b>
3.1 Features of EUT.....	6
3.2 General Description of EUT.....	6
3.3 Operating Modes of EUT and Determination of Worst Case Operating Mode.....	7
3.4 Test Program Used and Operation Descriptions .....	7
3.5 Primary Clock Frequencies of Internal Source .....	7
<b>4 Configuration and Connections with EUT.....</b>	<b>8</b>
4.1 Connection Diagram of EUT and Peripheral Devices .....	8
4.2 Configuration of Peripheral Devices and Cable Connections.....	9
<b>5 Conducted Emissions at Mains Ports .....</b>	<b>10</b>
5.1 Limits .....	10
5.2 Test Instruments.....	10
5.3 Test Arrangement.....	11
5.4 Test Results .....	12
<b>6 Radiated Emissions up to 1 GHz.....</b>	<b>14</b>
6.1 Limits .....	14
6.2 Test Instruments.....	15
6.3 Test Arrangement.....	16
6.4 Test Results .....	17
<b>7 Radiated Emissions above 1 GHz .....</b>	<b>19</b>
7.1 Limits .....	19
7.2 Test Instruments.....	20
7.3 Test Arrangement.....	21
7.4 Test Results .....	22
<b>8 Pictures of Test Arrangements .....</b>	<b>24</b>
8.1 Conducted Emissions at Mains Ports.....	24
8.2 Radiated Emissions up to 1 GHz.....	25
8.3 Radiated Emissions above 1 GHz .....	26
<b>Appendix – Information on the Testing Laboratories.....</b>	<b>27</b>

### Release Control Record

Issue No.	Description	Date Issued
FV170407D06	Original release.	May 18, 2017

## 1 Certificate of Conformity

**Product:** Ultra-Compact Embedded System

**Brand:** Vecow

**Test Model:** ECS-4500-PoER

**Series Model:** Vecow ECS-4500 Series; ECS-4500-PoE;  
ECS-4500-PDR; ECS-4500-PD; ECS-4500-2R; ECS-4500-2G;  
ECS-4XXXXXXXXXXXXXXXXXXXXX ("X" can be 0-9, A-Z or blank for marketing  
purpose)

**Sample Status:** Engineering sample

**Applicant:** Vecow Co., Ltd.

**Test Date:** Apr. 15 ~ 18, 2017

**Standards:** 47 CFR FCC Part 15, Subpart B, Class A  
ICES-003:2016 Issue 6, Class A  
ANSI C63.4:2014

The above equipment has been tested by **Bureau Veritas Consumer Products Services (H.K.) Ltd., Taoyuan Branch**, and found compliance with the requirement of the above standards. The test record, data evaluation & Equipment Under Test (EUT) configurations represented herein are true and accurate accounts of the measurements of the sample's EMC characteristics under the conditions specified in this report.

**Prepared by :**

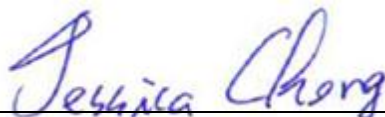

Jessica Cheng / Senior Specialist

**Date:** May 18, 2017

**Approved by :**

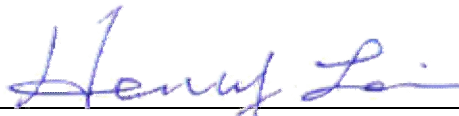

Henry Lai / Director

**Date:** May 18, 2017

## 2 Summary of Test Results

47 CFR FCC Part 15, Subpart B / ICES-003:2016 Issue 6, Class A

ANSI C63.4:2014

FCC Clause	ICES-003 Clause	Test Item	Result/Remarks	Verdict
15.107	6.1	AC Power Line Conducted Emissions	Minimum passing Class A margin is -12.60 dB at 0.15000 MHz	Pass
15.109	6.2.1	Radiated Emissions up to 1 GHz	Minimum passing Class A margin is -0.50 dB at 1000.00 MHz	Pass
	6.2.2	Radiated Emissions above 1 GHz	Minimum passing Class A margin is -11.45 dB at 1540.00 MHz	Pass

Note: There is no deviation to the applied test methods and requirements covered by the scope of this report.

### 2.1 Measurement Uncertainty

Where relevant, the following measurement uncertainty levels have been estimated for tests performed on the EUT:

The listed uncertainties are the worst case uncertainty for the entire range of measurement. Please note that the uncertainty values are provided for informational purposes only and are not used in determining the PASS/FAIL results.

Measurement	Frequency	Expanded Uncertainty (k=2) ( $\pm$ )
Conducted Emissions at mains ports	150kHz ~ 30MHz	2.77 dB
Radiated Emissions up to 1 GHz	30MHz ~ 1GHz	3.99 dB
Radiated Emissions above 1 GHz	Above 1GHz	4.77 dB

### 2.2 Modification Record

There were no modifications required for compliance.

### 3 General Information

#### 3.1 Features of EUT

The tests reported herein were performed according to the method specified by Vecow Co., Ltd., for detailed feature description, please refer to the manufacturer's specifications or user's manual.

#### 3.2 General Description of EUT

Product	Ultra-Compact Embedded System
Brand	Vecow
Test Model	ECS-4500-PoER
Series Model	Vecow ECS-4500 Series; ECS-4500-PoE; ECS-4500-PDR; ECS-4500-PD; ECS-4500-2R; ECS-4500-2G; ECS-4XXXXXXXXXXXXXXXXXXXXX ("X" can be 0-9, A-Z or blank for marketing purpose)
Model Difference	For marketing purpose
Sample Status	Engineering sample
Operating Software	Windows 10, Windows 8.1, Windows 7, Linux
Power Supply Rating	6V to 36V, DC-in
Accessory Device	Adapter
Data Cable Supplied	N/A

Note:

1. The EUT is a Ultra-Compact Embedded System with following interfaces:

- 2 COM\*4 (RS-232/ 422/ 485)
- 2 USB 3.0\*5 (External)
- 2 USB2.0\*3 (Internal)
- 2 Isolated DIO (16 Isolated DIO : 8 DI, 8 DO)
- 2 DVI-D (resolution up to 1920 x 1200 @ 60Hz)
- 2 Display\*2 (resolution up to 4096 x 2304 @ 60Hz)
- 2 Line out
- 2 Mic. in
- 2 LAN\*2 (10/100/1000Mbps)
- 2 POE LAN\*4 (10/100Mbps)
- 2 DC input (IGN)
- 2 CFast socket

2. The EUT was configured with the following key components:

Component	Brand	Model No. or P/N	Spec.
CPU	Intel®	Core™ i7-6600U Processor	Up to 3.4GHz
Memory	MEMXPRO	D4S8GHLPGEI	8GB DDR4 2400-17 SODIMM IT
CFast 2.0	Transcend	CFX600	64GB

3. The EUT uses following adapter.

Brand	MW
Model	GS160A24
Input Power	100-240Vac, 50/60Hz, 2.0A
Output Power	24Vdc, 6.67A, 160W max.
Power Line	Non-shielded DC (1.15m) with one ferrite core

### 3.3 Operating Modes of EUT and Determination of Worst Case Operating Mode

1. The EUT consumed DC power from AC adapter, which designed with AC power supply of 100-240Vac, 50/60Hz.  
For radiated emission evaluation, 230Vac/50Hz & 110Vac/60Hz (for EN 55032), 230Vac/50Hz (for EN 55011), 120Vac/60Hz (for FCC Part 15) had been covered during the pre-test. The worst data was found at **230Vac/50Hz** and recorded in the applied test report Then the other test items were tested at 120Vac/60Hz.
2. Test modes are presented in the report as below.

Mode	Test Condition	Input Power
Conducted emission test		
1	Full system, DPx2 3840x1260 60Hz*+DVI 1920x1200 60Hz	120Vac/ 60Hz (Adapter)
Radiated emission test		
1	Full system, DPx2 3840x1260 60Hz*+DVI 1920x1200 60Hz	230Vac/ 50Hz (Adapter)

**Note:** \*The maximum resolution of the external display monitor is 3840\*1260 60Hz.

### 3.4 Test Program Used and Operation Descriptions

- a. Turned on the power of all equipment.
- b. EUT ran a test program to enable all functions.
- c. EUT read and wrote messages from/to card reader, SSD and ext. HDDs.
- d. EUT sent and received messages to/from Notebook PCs (kept in a remote area) via two UTP LAN cables.
- e. EUT sent "H" messages to ext. LCD Monitors. Then they displayed "H" patterns on their screens simultaneously.
- f. EUT sent 1kHz audio signal to earphone.
- g. EUT sent messages to printer and printer printed them out.
- h. Cameras captured video image to LCD Monitors via EUT.
- i. Steps c- were repeated.

### 3.5 Primary Clock Frequencies of Internal Source

The highest frequency generated or used within the EUT or on which the EUT operates or tunes is 3400 MHz, provided by Vecow Co., Ltd., for detailed internal source, please refer to the manufacturer's specifications.

## 4 Configuration and Connections with EUT

### 4.1 Connection Diagram of EUT and Peripheral Devices

#### TEST CONFIGURATION

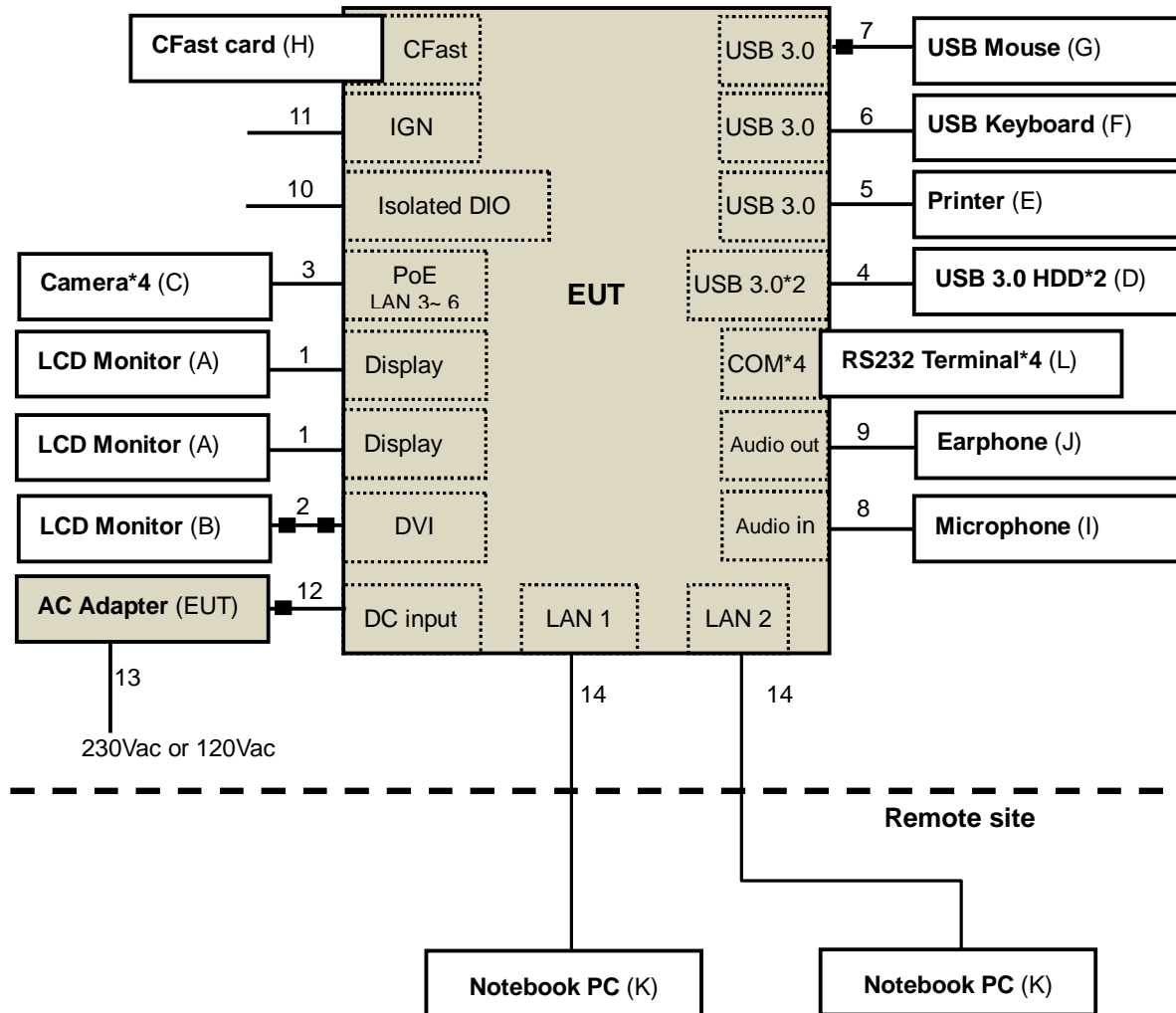



#### 4.2 Configuration of Peripheral Devices and Cable Connections

ID	Product	Brand	Model No.	Serial No.	FCC ID	Remarks
A.	LCD Monitor	HP	HP Z24s	6CM5172L58	FCC DoC Approved	Provided by Lab
	LCD Monitor	HP	HP Z24s	6CM5172L56	FCC DoC Approved	Provided by Lab
B.	24" LCD MONITOR	DELL	U2410	CN082WXD728720CC OYAL	FCC DoC Approved	Provided by Lab
C.	2M Fixed Mini Indoor Dome Nework Camera*2	N/A	A200MIF-HNG-03	N/A	N/A	Supplied by client
	3M Fixed Mini Indoor Dome Nework Camera*2	N/A	A301MIF-3N	N/A	N/A	Supplied by client
D.	USB 3.0 Hard Disk	WD	WDBUZG0010BBK-PESN	WX61A45JR2YK	FCC DoC Approved	Provided by Lab
	USB 3.0 Hard Disk	WD	WDBUZG0010BBK-PESN	WXN1E84F21W	FCC DoC Approved	Provided by Lab
E.	PRINTER	hp	Snprc-1203-01	N/A	B94SDGOB	Provided by Lab
F.	USB KEYBOARD	BTC	5200U	G09302046628	E5XKB5122U	Provided by Lab
G.	USB Mouse	Microsoft	1113	9170514606552	FCC DoC Approved	Provided by Lab
H.	CF Card	Transcend	CFX600 64GB	N/A	N/A	Supplied by client
I.	MICROPHONE	Labtec	mic-333	N/A	N/A	Provided by Lab
J.	EARPHONE	PHILIPS	SBC HL145	N/A	N/A	Provided by Lab
K.	Notebook PC	ASUS	PU401L	ECNXBC012528528	FCC DoC Approved	Provided by Lab
	Notebook PC	ASUS	PU401L	E9NXBC002007372	FCC DoC Approved	Provided by Lab
L.	COM Load*4	N/A	N/A	N/A	N/A	Supplied by client

Note:

1. All power cords of the above support units are non-shielded (1.8m).
2. Items K acted as communication partners to transfer data.

ID	Descriptions	Qty.	Length (m)	Shielding (Yes/No)	Cores (Qty.)	Remarks
1.	DP cable	2	1.8	Y	0	Provided by Lab
2.	DVI cable	1	1.8	Y	2	Provided by Lab
3.	LAN cable	4	3	N	0	Provided by Lab
4.	USB cable	2	0.5	Y	0	Provided by Lab
5.	USB cable	1	1.5	Y	0	Provided by Lab
6.	USB cable	1	1.8	Y	0	Provided by Lab
7.	USB cable	1	1.8	Y	1	Provided by Lab
8.	Audio cable	1	2.0	N	0	Provided by Lab
9.	Audio cable	1	1.5	N	0	Provided by Lab
10.	Signal	1	0.8	N	0	Provided by Lab
11.	Signal	1	0.5	N	0	Supplied by client
12.	DC cable	1	1.15	N	1	Supplied by client
13.	AC power cord	1	1.8	N	0	Provided by Lab
14.	LAN cable	2	10	N	0	Provided by Lab

Note: The core(s) is(are) originally attached to the cable(s).

## 5 Conducted Emissions at Mains Ports

### 5.1 Limits

Frequency (MHz)	Class A (dBuV)		Class B (dBuV)	
	Quasi-peak	Average	Quasi-peak	Average
0.15 - 0.5	79	66	66 - 56	56 - 46
0.50 - 5.0	73	60	56	46
5.0 - 30.0	73	60	60	50

Notes: 1. The lower limit shall apply at the transition frequencies.  
 2. The limit decreases linearly with the logarithm of the frequency in the range of 0.15 to 0.50 MHz.

### 5.2 Test Instruments

Description & Manufacturer	Model No.	Serial No.	Cal. Date	Cal. Due
ROHDE & SCHWARZ TEST RECEIVER	ESCS 30	100276	Apr. 10, 2017	Apr. 09, 2018
ROHDE & SCHWARZ Artificial Mains Network (for EUT)	ENV216	101197	May 04, 2016	May 03, 2017
LISN With Adapter (for EUT)	AD10	C10Ada-002	May 04, 2016	May 03, 2017
ROHDE & SCHWARZ Artificial Mains Network (for peripherals)	ESH3-Z5	100218	Nov. 23, 2016	Nov. 22, 2017
SCHWARZBECK Artificial Mains Network (For EUT)	NNLK8129	8129229	May 04, 2016	May 03, 2017
Software	Cond_V7.3.7.4	NA	NA	NA
RF cable (JYEBAO) With 10dB PAD	5D-FB	Cable-C10.01	Feb. 14, 2017	Feb. 13, 2018
SUHNER Terminator (For ROHDE & SCHWARZ LISN)	65BNC-5001	E1-011484	May 12, 2016	May 11, 2017
ROHDE & SCHWARZ Artificial Mains Network (For TV EUT)	ESH3-Z5	100220	Nov. 08, 2016	Nov. 07, 2017
LISN With Adapter (for TV EUT)	100220	N/A	Nov. 08, 2016	Nov. 07, 2017

Notes: 1. The calibration interval of the above test instruments is 12 months and the calibrations are traceable to NML/ROC and NIST/USA.  
 2. The test was performed in Shielded Room No. 10.  
 3. The VCCI Site Registration No. C-1852.  
 4. Tested Date: Apr. 17, 2017.

### 5.3 Test Arrangement

- The EUT was placed 0.4 meters from the conducting wall of the shielded room with EUT being connected to the power mains through a line impedance stabilization network (LISN). Other support units were connected to the power mains through another LISN. The two LISNs provide 50 Ohm/ 50uH of coupling impedance for the measuring instrument.
- Both lines of the power mains connected to the EUT were checked for maximum conducted interference.
- The test results of conducted emissions at mains ports are recorded of six worst margins for quasi-peak (mandatory) [and average (if necessary)] values against the limits at frequencies of interest unless the margin is 20 dB or greater.

Note: The resolution bandwidth and video bandwidth of test receiver is 9kHz for quasi-peak detection (QP) and average detection (AV) at frequency 0.15MHz-30MHz.

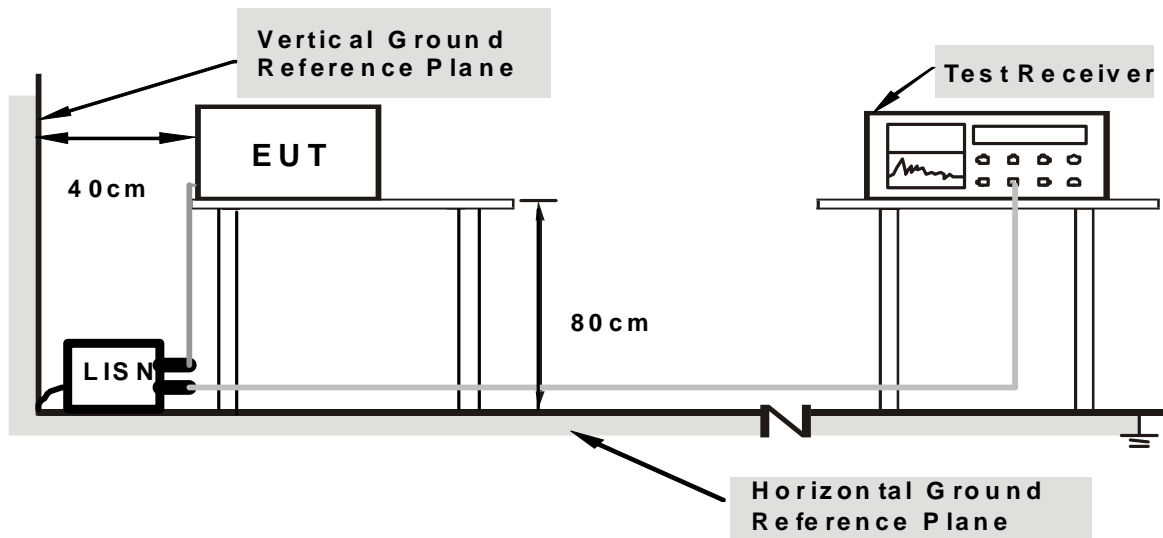

**Note: Support units were connected to second LISN.**

For the actual test configuration, please refer to the related item – Photographs of the Test Configuration.

## 5.4 Test Results

<b>Frequency Range</b>	150kHz ~ 30MHz	<b>Detector Function &amp; Resolution Bandwidth</b>	Quasi-Peak (QP) / Average (AV), 9kHz
<b>Input Power</b>	120Vac, 60Hz (Adapter)	<b>Environmental Conditions</b>	22°C, 65%RH
<b>Tested by</b>	Adam Chen		
<b>Test Mode</b>	Mode 1		

Phase Of Power : Line (L)										
No	Frequency (MHz)	Correction Factor (dB)	Reading Value (dBuV)		Emission Level (dBuV)		Limit (dBuV)		Margin (dB)	
			Q.P.	AV.	Q.P.	AV.	Q.P.	AV.	Q.P.	AV.
1	0.15000	9.70	46.39	41.14	56.09	50.84	79.00	66.00	-22.91	-15.16
2	0.19805	9.71	33.96	13.39	43.67	23.10	79.00	66.00	-35.33	-42.90
3	7.96056	9.94	32.03	31.49	41.97	41.43	73.00	60.00	-31.03	-18.57
4	8.75911	9.95	32.07	31.90	42.02	41.85	73.00	60.00	-30.98	-18.15
5	9.55549	9.95	29.32	28.49	39.27	38.44	73.00	60.00	-33.73	-21.56
6	23.87118	9.98	29.00	20.83	38.98	30.81	73.00	60.00	-34.02	-29.19

### Remarks:

1. Q.P. and AV. are abbreviations of quasi-peak and average individually.
2. The emission levels of other frequencies were very low against the limit.
3. Margin value = Emission level – Limit value
4. Correction factor = Insertion loss + Cable loss
5. Emission Level = Correction Factor + Reading Value

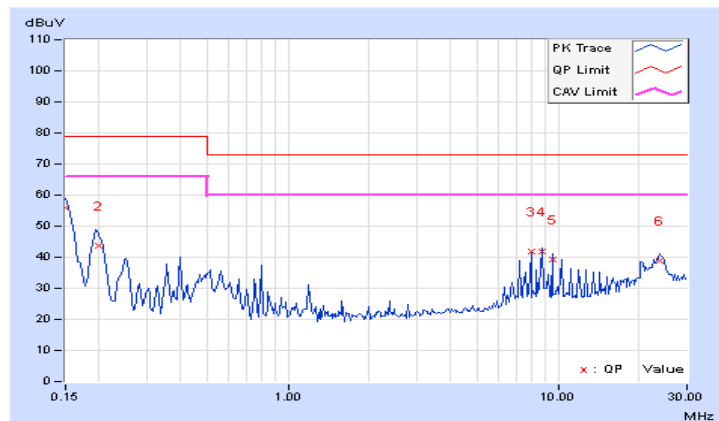

<b>Frequency Range</b>	150kHz ~ 30MHz	<b>Detector Function &amp; Resolution Bandwidth</b>	Quasi-Peak (QP) / Average (AV), 9kHz
<b>Input Power</b>	120Vac, 60Hz (Adapter)	<b>Environmental Conditions</b>	22°C, 65%RH
<b>Tested by</b>	Adam Chen		
<b>Test Mode</b>	Mode 1		

Phase Of Power : Neutral (N)										
No	Frequency (MHz)	Correction Factor (dB)	Reading Value (dBuV)		Emission Level (dBuV)		Limit (dBuV)		Margin (dB)	
			Q.P.	AV.	Q.P.	AV.	Q.P.	AV.	Q.P.	AV.
1	0.15000	9.70	46.47	43.70	56.17	53.40	79.00	66.00	-22.83	-12.60
2	0.19687	9.70	33.94	12.37	43.64	22.07	79.00	66.00	-35.36	-43.93
3	7.97273	9.93	33.58	32.53	43.51	42.46	73.00	60.00	-29.49	-17.54
4	8.77326	9.94	32.91	32.24	42.85	42.18	73.00	60.00	-30.15	-17.82
5	9.57268	9.95	29.42	28.78	39.37	38.73	73.00	60.00	-33.63	-21.27
6	24.69141	9.96	23.91	15.89	33.87	25.85	73.00	60.00	-39.13	-34.15

**Remarks:**

1. Q.P. and AV. are abbreviations of quasi-peak and average individually.
2. The emission levels of other frequencies were very low against the limit.
3. Margin value = Emission level – Limit value
4. Correction factor = Insertion loss + Cable loss
5. Emission Level = Correction Factor + Reading Value

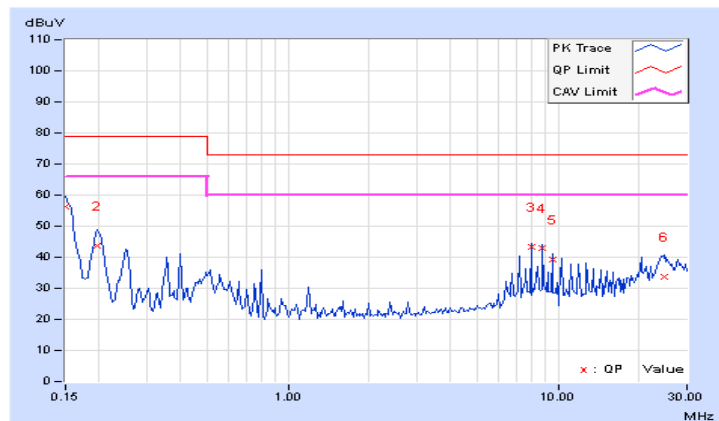

## 6 Radiated Emissions up to 1 GHz

### 6.1 Limits

Emissions radiated outside of the specified bands, shall be according to the general radiated limits as following:

Radiated Emissions Limits at 10 meters (dB $\mu$ V/m)				
Frequencies (MHz)	FCC 15B / ICES-003, Class A	FCC 15B / ICES-003, Class B	CISPR 22, Class A	CISPR 22, Class B
30-88	39	29.5	40	30
88-216	43.5	33.1		
216-230	46.4	35.6		
230-960			47	37
960-1000	49.5	43.5		

Radiated Emissions Limits at 3 meters (dB $\mu$ V/m)				
Frequencies (MHz)	FCC 15B / ICES-003, Class A	FCC 15B / ICES-003, Class B	CISPR 22, Class A	CISPR 22, Class B
30-88	49.5	40	50.5	40.5
88-216	54	43.5		
216-230	56.9	46		
230-960			57.5	47.5
960-1000	60	54		

- Notes:
1. The lower limit shall apply at the transition frequencies.
  2. Emission level (dB $\mu$ V/m) = 20 log Emission level (uV/m).
  3. QP detector shall be applied if not specified.

## 6.2 Test Instruments

Description & Manufacturer	Model No.	Serial No.	Cal. Date	Cal. Due
ROHDE & SCHWARZ TEST RECEIVER	ESCS 30	845552/004	Sep. 19, 2016	Sep. 18, 2017
Schaffner Bilog Antenna	CBL6111D	22262	Dec. 28, 2016	Dec. 27, 2017
Agilent Preamplifier	8447D	2944A08119	Feb. 21, 2017	Feb. 20, 2018
ADT. Turn Table	TT100	0205	NA	NA
ADT. Tower	AT100	0205	NA	NA
Software	Radiated_V7.6.15.9.5	NA	NA	NA
ADT RF Switches BOX	EMH-011	1001	Oct. 28, 2016	Oct. 27, 2017
Pacific RF cable With 5dB PAD	8D	CABLE-ST2-01	Oct. 28, 2016	Oct. 27, 2017

- Notes: 1. The calibration interval of the above test instruments is 12 months and the calibrations are traceable to NML/ROC and NIST/USA.
2. The test was performed in Open Site No. 2.
3. The VCCI Site Registration No. R-237.
4. The FCC Site Registration No. 90424.
5. Tested Date: Apr. 18, 2017.

### 6.3 Test Arrangement

- The EUT was placed on the top of a rotating table 0.8 meters above the ground at an accredited test facility. The table was rotated 360 degrees to determine the position of the highest radiation.
- The EUT was set 10 meters away from the interference-receiving antenna, which was mounted on the top of a variable-height antenna tower.
- The antenna is a broadband antenna, and its height is varied from one meter to four meters above the ground to determine the maximum value of the field strength. Both horizontal and vertical polarizations of the antenna are set to make the measurement.
- For each suspected emission, the EUT was arranged to its worst case and then the antenna was tuned to heights from 1 meter to 4 meters and the rotatable table was turned from 0 degrees to 360 degrees to find the maximum reading.
- The test-receiver system was set to quasi-peak detect function and specified bandwidth with maximum hold mode when the test frequency is up to 1 GHz.

Note: The resolution bandwidth and video bandwidth of test receiver/spectrum analyzer is 120kHz for quasi-peak detection (QP) at frequency up to 1GHz.

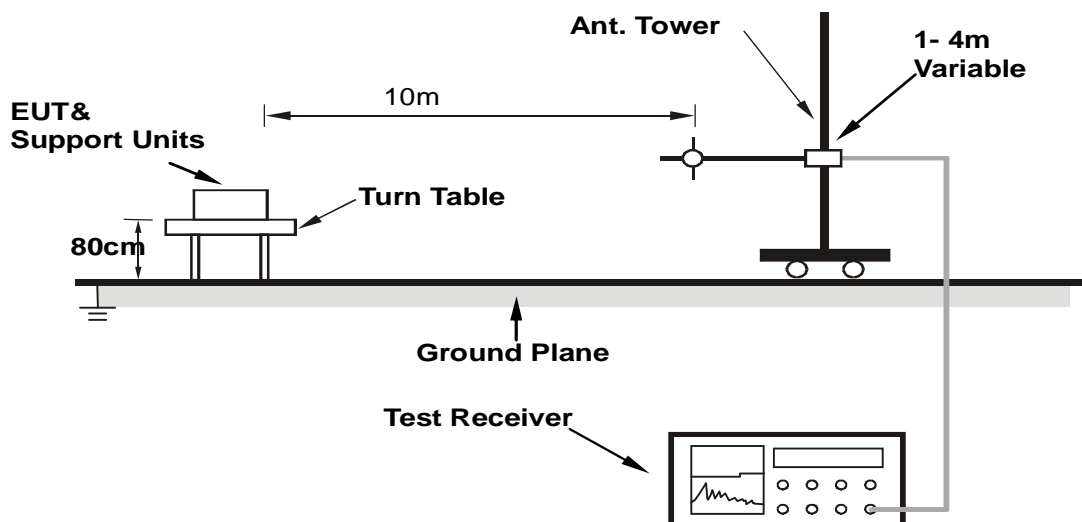

For the actual test configuration, please refer to the related item – Photographs of the Test Configuration.



### 6.4 Test Results

<b>Frequency Range</b>	30MHz ~ 1GHz	<b>Detector Function &amp; Resolution Bandwidth</b>	Quasi-Peak (QP), 120kHz
<b>Tested by</b>	ED. Lin	<b>Environmental Conditions</b>	28°C, 74%RH
<b>Test Mode</b>	Mode 1		

Antenna Polarity & Test Distance : Horizontal at 10 m								
No	Frequency (MHz)	Emission Level (dBuV/m)	Limit (dBuV/m)	Margin (dB)	Antenna Height (m)	Table Angle (Degree)	Raw Value (dBuV)	Correction Factor (dB/m)
1	74.81	31.53 QP	40.00	-8.47	4.00 H	55	48.45	-16.92
2	146.12	27.15 QP	40.00	-12.85	3.63 H	225	39.13	-11.98
3	225.12	29.43 QP	40.00	-10.57	3.31 H	298	42.03	-12.60
4	540.25	37.66 QP	47.00	-9.34	2.56 H	26	41.15	-3.49
5	601.00	38.56 QP	47.00	-8.44	1.43 H	336	40.67	-2.11
6	745.00	38.76 QP	47.00	-8.24	1.41 H	59	37.38	1.38
7	875.01	38.79 QP	47.00	-8.21	1.00 H	347	35.83	2.96
<b>8</b>	<b>1000.00</b>	<b>46.50 QP</b>	<b>47.00</b>	<b>-0.50</b>	<b>1.00 H</b>	<b>21</b>	<b>40.90</b>	<b>5.60</b>

Remarks:

1. Emission Level(dBuV/m) = Raw Value(dBuV) + Correction Factor(dB/m)
2. Correction Factor(dB/m) = Antenna Factor (dB/m) + Cable Factor (dB) – Pre-Amplifier Factor (dB)
3. The other emission levels were very low against the limit.
4. Margin value = Emission level – Limit value

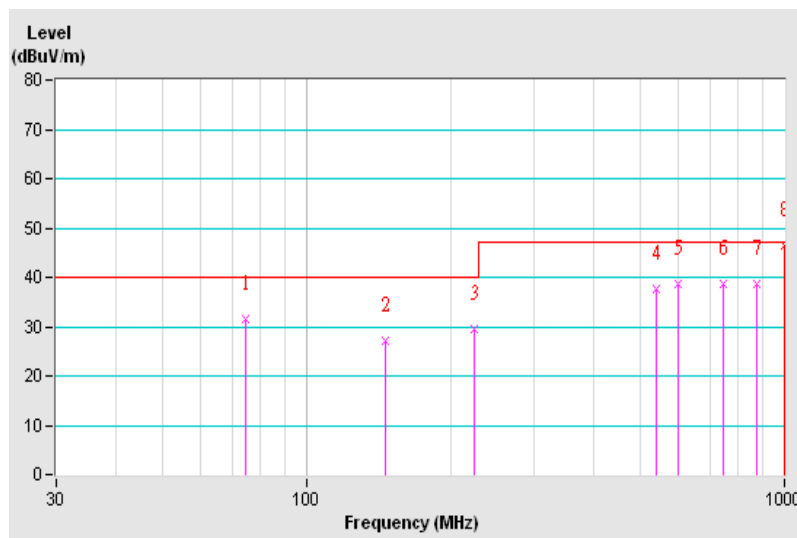

<b>Frequency Range</b>	30MHz ~ 1GHz	<b>Detector Function &amp; Resolution Bandwidth</b>	Quasi-Peak (QP), 120kHz
<b>Tested by</b>	ED. Lin	<b>Environmental Conditions</b>	28°C, 74%RH
<b>Test Mode</b>	Mode 1		

Antenna Polarity & Test Distance : Vertical at 10 m								
No	Frequency (MHz)	Emission Level (dBuV/m)	Limit (dBuV/m)	Margin (dB)	Antenna Height (m)	Table Angle (Degree)	Raw Value (dBuV)	Correction Factor (dB/m)
1	61.47	34.11 QP	40.00	-5.89	1.00 V	198	52.23	-18.12
2	82.06	36.43 QP	40.00	-3.57	1.87 V	303	52.80	-16.37
3	104.90	31.95 QP	40.00	-8.05	1.00 V	183	45.12	-13.17
4	125.02	35.21 QP	40.00	-4.79	1.00 V	122	46.94	-11.73
5	253.00	37.59 QP	47.00	-9.41	1.92 V	173	46.89	-9.30
6	440.50	36.61 QP	47.00	-10.39	2.28 V	176	41.79	-5.18
7	601.00	38.63 QP	47.00	-8.37	3.02 V	163	40.74	-2.11
8	616.01	41.64 QP	47.00	-5.36	1.00 V	128	43.36	-1.72
9	746.50	41.20 QP	47.00	-5.80	2.93 V	162	39.76	1.44
10	1000.00	45.31 QP	47.00	-1.69	2.06 V	160	39.71	5.60

Remarks:

1. Emission Level(dBuV/m) = Raw Value(dBuV) + Correction Factor(dB/m)
2. Correction Factor(dB/m) = Antenna Factor (dB/m) + Cable Factor (dB) – Pre-Amplifier Factor (dB)
3. The other emission levels were very low against the limit.
4. Margin value = Emission level – Limit value

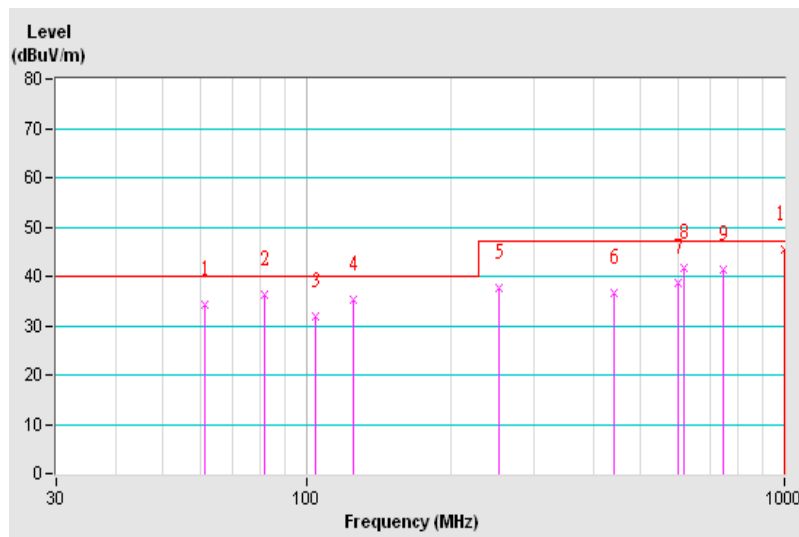

## 7 Radiated Emissions above 1 GHz

### 7.1 Limits

Emissions radiated outside of the specified bands, shall be according to the general radiated limits as following:

Radiated Emissions Limits at 10 meters (dB $\mu$ V/m)				
Frequencies (MHz)	FCC 15B / ICES-003, Class A	FCC 15B / ICES-003, Class B	CISPR 22, Class A	CISPR 22, Class B
1000-3000	Avg: 49.5	Avg: 43.5	Not defined	Not defined
Above 3000	Peak: 69.5	Peak: 63.5	Not defined	Not defined

Radiated Emissions Limits at 3 meters (dB $\mu$ V/m)				
Frequencies (MHz)	FCC 15B / ICES-003, Class A	FCC 15B / ICES-003, Class B	CISPR 22, Class A	CISPR 22, Class B
1000-3000	Avg: 60	Avg: 54	Avg: 56 Peak: 76	Avg: 50 Peak: 70
Above 3000	Peak: 80	Peak: 74	Avg: 60 Peak: 80	Avg: 54 Peak: 74

- Notes:
1. The lower limit shall apply at the transition frequencies.
  2. Emission level (dB $\mu$ V/m) = 20 log Emission level (uV/m).
  3. As shown in 15.35(b), for frequencies above 1000MHz, the field strength limits are based on average detector, however, the peak field strength of any emission shall not exceed the maximum permitted average limits, specified above by more than 20dB under any condition of modulation.

Frequency Range (For unintentional radiators)

Highest frequency generated or used in the device or on which the device operates or tunes (MHz)	Upper frequency of measurement range (MHz)
Below 1.705	30
1.705-108	1000
108-500	2000
500-1000	5000
Above 1000	5th harmonic of the highest frequency or 40GHz, whichever is lower

## 7.2 Test Instruments

Description & Manufacturer	Model No.	Serial No.	Cal. Date	Cal. Due
Agilent Spectrum	E4446A	MY51100009	May 30, 2016	May 29, 2017
Agilent Test Receiver	N9038A	MY51210129	Feb. 08, 2017	Feb. 07, 2018
Agilent Preamplifier	8449B	3008A01201	Feb. 22, 2017	Feb. 21, 2018
MITEQ Preamplifier	AMF-6F-260400-33-8P	892164	Feb. 21, 2017	Feb. 20, 2018
EMCI Preamplifier	EMC184045B	980235	Feb. 22, 2017	Feb. 21, 2018
Schwarzbeck Horn Antenna	BBHA-9170	212	Dec. 30, 2016	Dec. 29, 2017
Schwarzbeck Horn Antenna	BBHA 9120-D1	D130	Dec. 27, 2016	Dec. 26, 2017
ADT. Turn Table	TT100	0306	NA	NA
ADT. Tower	AT100	0306	NA	NA
Software	Radiated_V8.7.08	NA	NA	NA
SUHNER RF cable With 4dB PAD	SF104	Cable-CH6	Aug. 15, 2016	Aug. 14, 2017
SUHNER RF cable With 3dB PAD	SF102	Cable-CH8-02(3.6m)	Aug. 15, 2016	Aug. 14, 2017

- Notes: 1. The calibration interval of the above test instruments is 12 months and the calibrations are traceable to NML/ROC and NIST/USA.
2. The test was performed in Chamber No. 6.
3. The Industry Canada Reference No. IC 7450E-6.
4. The VCCI Site Registration No. G-257.
5. The FCC Site Registration No. 447212.
6. Tested Date: Apr. 15, 2017.

### 7.3 Test Arrangement

- The EUT was placed on the top of a rotating table 0.8 meters above the ground at an accredited chamber room. The table was rotated 360 degrees to determine the position of the highest radiation.
- The EUT was set 3 meters away from the interference-receiving antenna, which was mounted on the top of a variable-height antenna tower.
- The height of antenna can be varied from one meter to four meters, the height of adjustment depends on the EUT height and the antenna 3dB beamwidth both, to detect the maximum value of the field strength. Both horizontal and vertical polarizations of the antenna are set to make the measurement.
- For each suspected emission, the EUT was arranged to its worst case and then the antenna was tuned to heights and the rotatable table was turned from 0 degrees to 360 degrees to find the maximum reading.
- The spectrum analyzer system was set to peak and average detect function and specified bandwidth with maximum hold mode when the test frequency is above 1 GHz.

Note: The resolution bandwidth of test receiver/spectrum analyzer is 1MHz and video bandwidth is 3MHz for Peak detection (PK) at frequency above 1GHz. The resolution bandwidth of test receiver/spectrum analyzer is 1 MHz for Average detection (AV) at frequency above 1GHz.

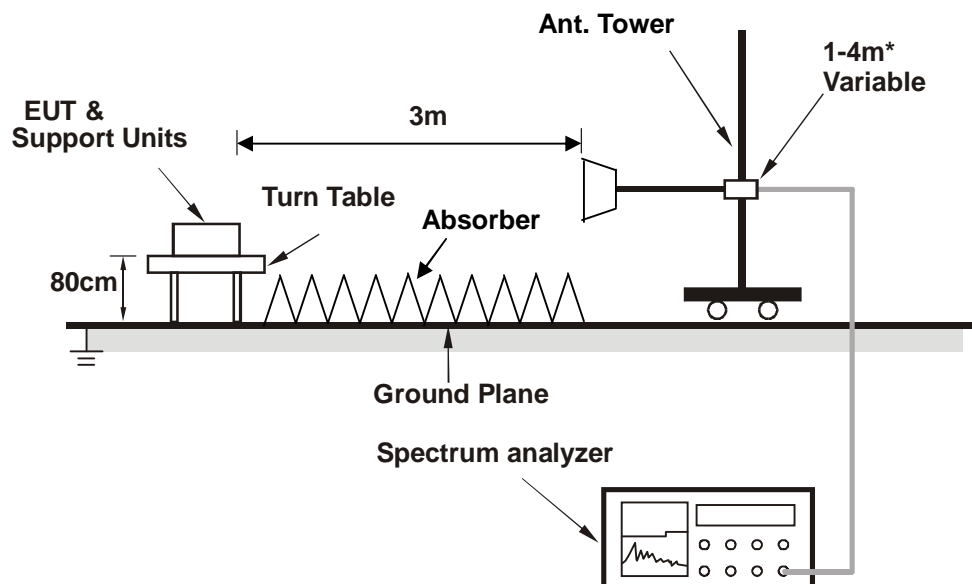

\* :depends on the EUT height and the antenna 3dB beamwidth both.

For the actual test configuration, please refer to the related item – Photographs of the Test Configuration.

### 7.4 Test Results

Frequency Range	1GHz ~ 17GHz	Detector Function & Resolution Bandwidth	Peak (PK) / Average (AV), 1MHz
Tested by	ED. Lin	Environmental Conditions	27°C, 70%RH
Test Mode	Mode 1		

Antenna Polarity & Test Distance : Horizontal at 3 m								
No	Frequency (MHz)	Emission Level (dBuV/m)	Limit (dBuV/m)	Margin (dB)	Antenna Height (m)	Table Angle (Degree)	Raw Value (dBuV)	Correction Factor (dB/m)
1	1125.04	47.87 PK	80.00	-32.13	1.00 H	270	52.99	-5.12
2	1125.04	39.58 AV	60.00	-20.42	1.00 H	270	44.70	-5.12
3	1430.74	45.13 PK	80.00	-34.87	2.38 H	86	49.24	-4.11
4	1430.74	28.94 AV	60.00	-31.06	2.38 H	86	33.05	-4.11
5	1540.00	57.35 PK	80.00	-22.65	1.00 H	224	61.19	-3.84
<b>6</b>	<b>1540.00</b>	<b>48.55 AV</b>	<b>60.00</b>	<b>-11.45</b>	<b>1.00 H</b>	<b>224</b>	<b>52.39</b>	<b>-3.84</b>
7	2132.57	52.87 PK	80.00	-27.13	1.44 H	124	55.07	-2.20
8	2132.57	33.62 AV	60.00	-26.38	1.44 H	124	35.82	-2.20

Remarks:

1. Emission Level(dBuV/m) = Raw Value(dBuV) + Correction Factor(dB/m)
2. Correction Factor(dB/m) = Antenna Factor (dB/m) + Cable Factor (dB) – Pre-Amplifier Factor (dB)
3. The other emission levels were very low against the limit.
4. Margin value = Emission level – Limit value

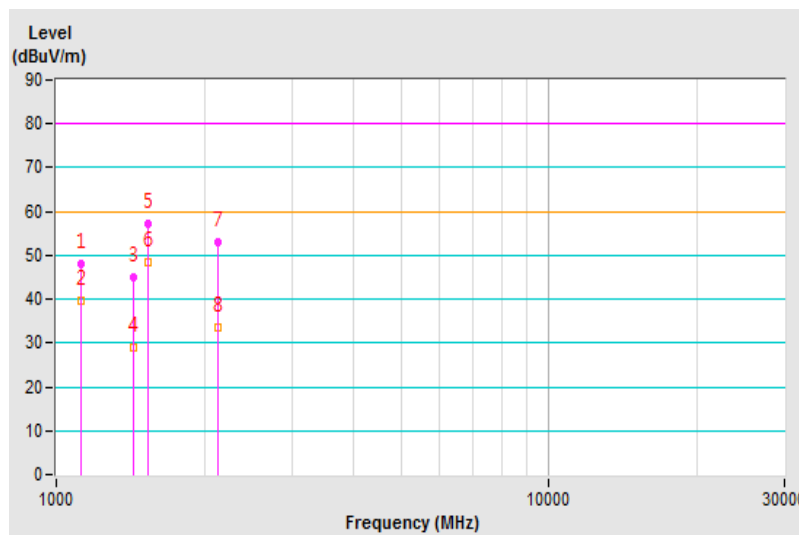

<b>Frequency Range</b>	1GHz ~ 17GHz	<b>Detector Function &amp; Resolution Bandwidth</b>	Peak (PK) / Average (AV), 1MHz
<b>Tested by</b>	ED. Lin	<b>Environmental Conditions</b>	27°C, 70%RH
<b>Test Mode</b>	Mode 1		

Antenna Polarity & Test Distance : Vertical at 3 m								
No	Frequency (MHz)	Emission Level (dBuV/m)	Limit (dBuV/m)	Margin (dB)	Antenna Height (m)	Table Angle (Degree)	Raw Value (dBuV)	Correction Factor (dB/m)
1	1125.04	50.30 PK	80.00	-29.70	1.00 V	184	55.42	-5.12
2	1125.04	41.48 AV	60.00	-18.52	1.00 V	184	46.60	-5.12
3	1417.27	50.59 PK	80.00	-29.41	1.94 V	11	54.75	-4.16
4	1417.27	30.90 AV	60.00	-29.10	1.94 V	11	35.06	-4.16
5	1539.99	55.81 PK	80.00	-24.19	1.48 V	235	59.65	-3.84
6	1539.99	46.60 AV	60.00	-13.40	1.48 V	235	50.44	-3.84
7	5024.44	48.21 PK	80.00	-31.79	2.50 V	77	40.82	7.39
8	5024.44	35.32 AV	60.00	-24.68	2.50 V	77	27.93	7.39

Remarks:

1. Emission Level(dBuV/m) = Raw Value(dBuV) + Correction Factor(dB/m)
2. Correction Factor(dB/m) = Antenna Factor (dB/m) + Cable Factor (dB) – Pre-Amplifier Factor (dB)
3. The other emission levels were very low against the limit.
4. Margin value = Emission level – Limit value

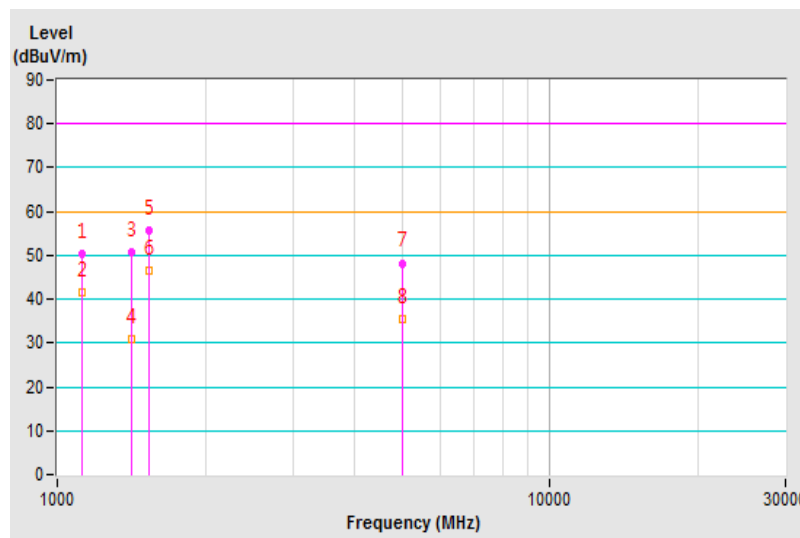

## 8 Pictures of Test Arrangements

### 8.1 Conducted Emissions at Mains Ports

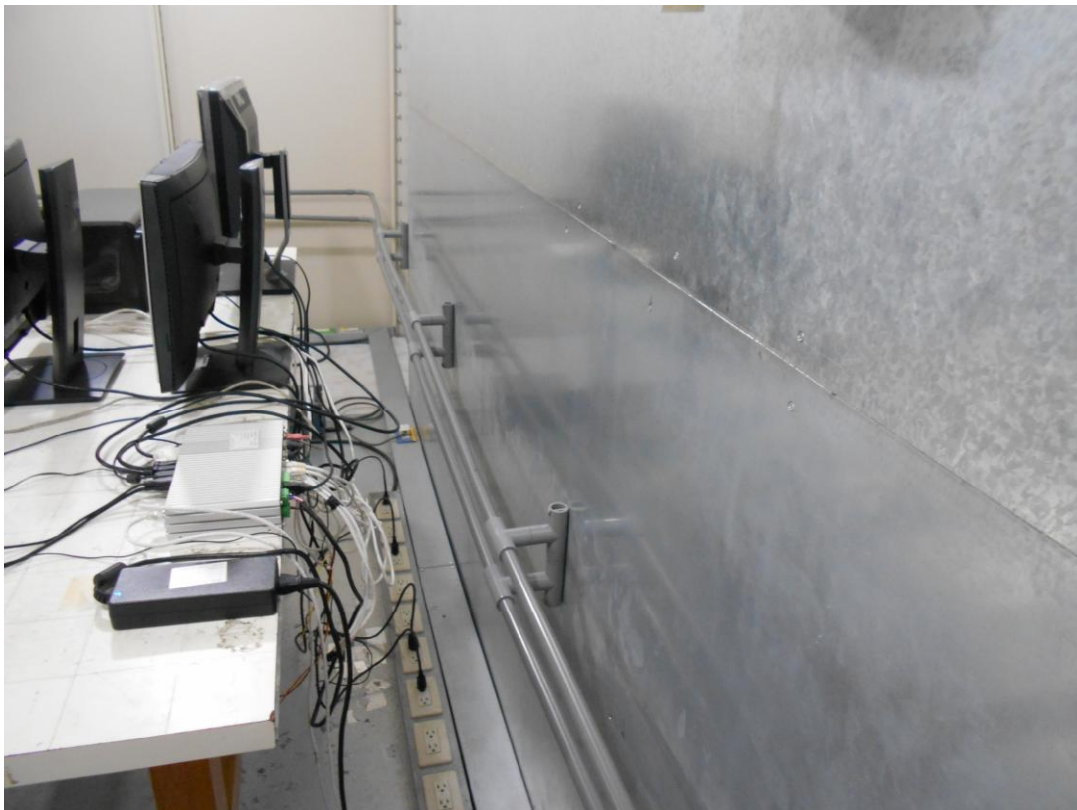



## 8.2 Radiated Emissions up to 1 GHz



### 8.3 Radiated Emissions above 1 GHz

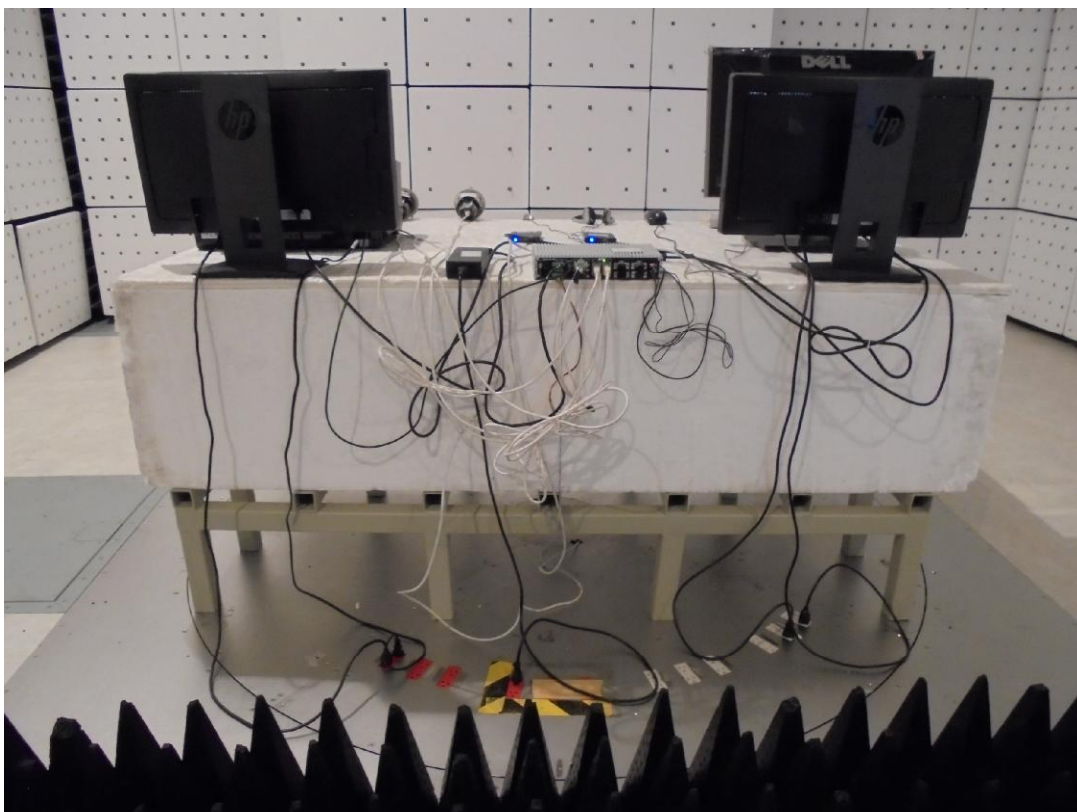
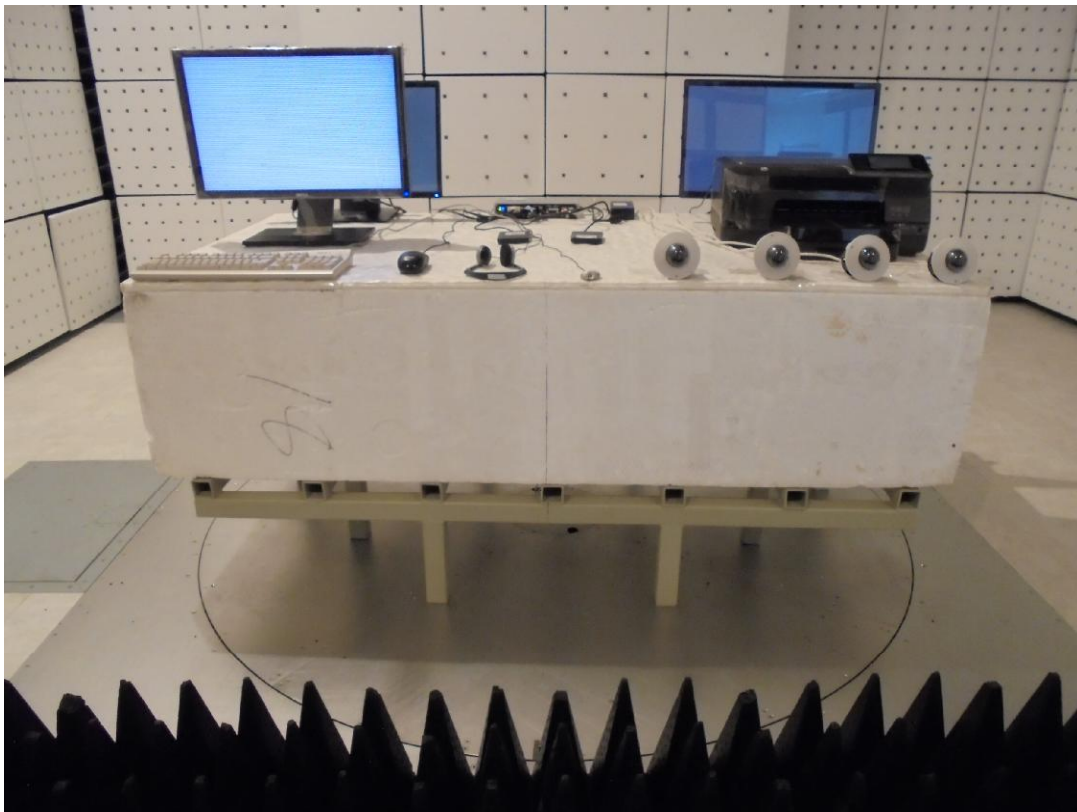

## Appendix – Information on the Testing Laboratories

We, Bureau Veritas Consumer Products Services (H.K.) Ltd., Taoyuan Branch, were founded in 1988 to provide our best service in EMC, Radio, Telecom and Safety consultation. Our laboratories are accredited and approved according to ISO/IEC 17025.

If you have any comments, please feel free to contact us at the following:

**Linko EMC/RF Lab**

Tel: 886-2-26052180

Fax: 886-2-26051924

**Hsin Chu EMC/RF/Telecom Lab**

Tel: 886-3-6668565

Fax: 886-3-6668323

**Hwa Ya EMC/RF/Safety Lab**

Tel: 886-3-3183232

Fax: 886-3-3270892

**Email:** [service.adt@tw.bureauveritas.com](mailto:service.adt@tw.bureauveritas.com)

**Web Site:** [www.bureauveritas-adt.com](http://www.bureauveritas-adt.com)

The address and road map of all our labs can be found in our web site also.

--- END ---